

ELECTRO DISTRIBUTEUR A TIROIR	Taille 5 Size 5 NG 10	ISO 4401	<b>HDE 6JD</b>
DIRECTIONAL CONTROL VALVE SPOOL TYPE			

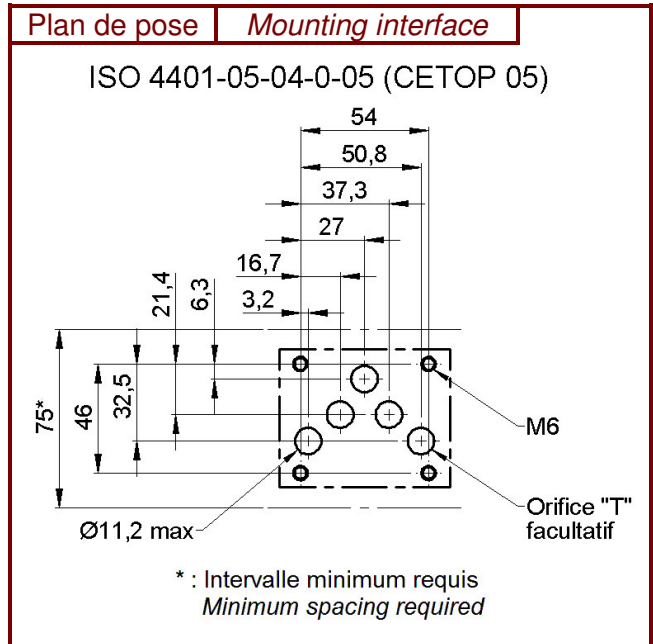

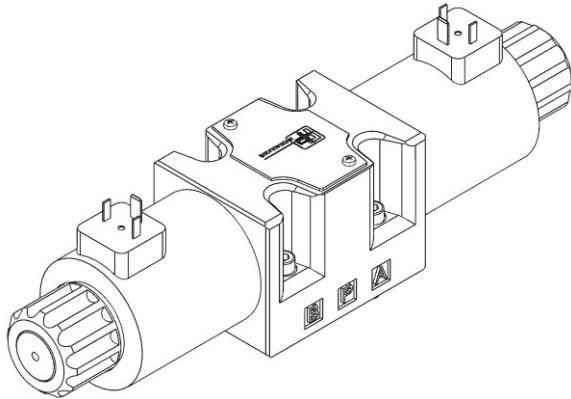

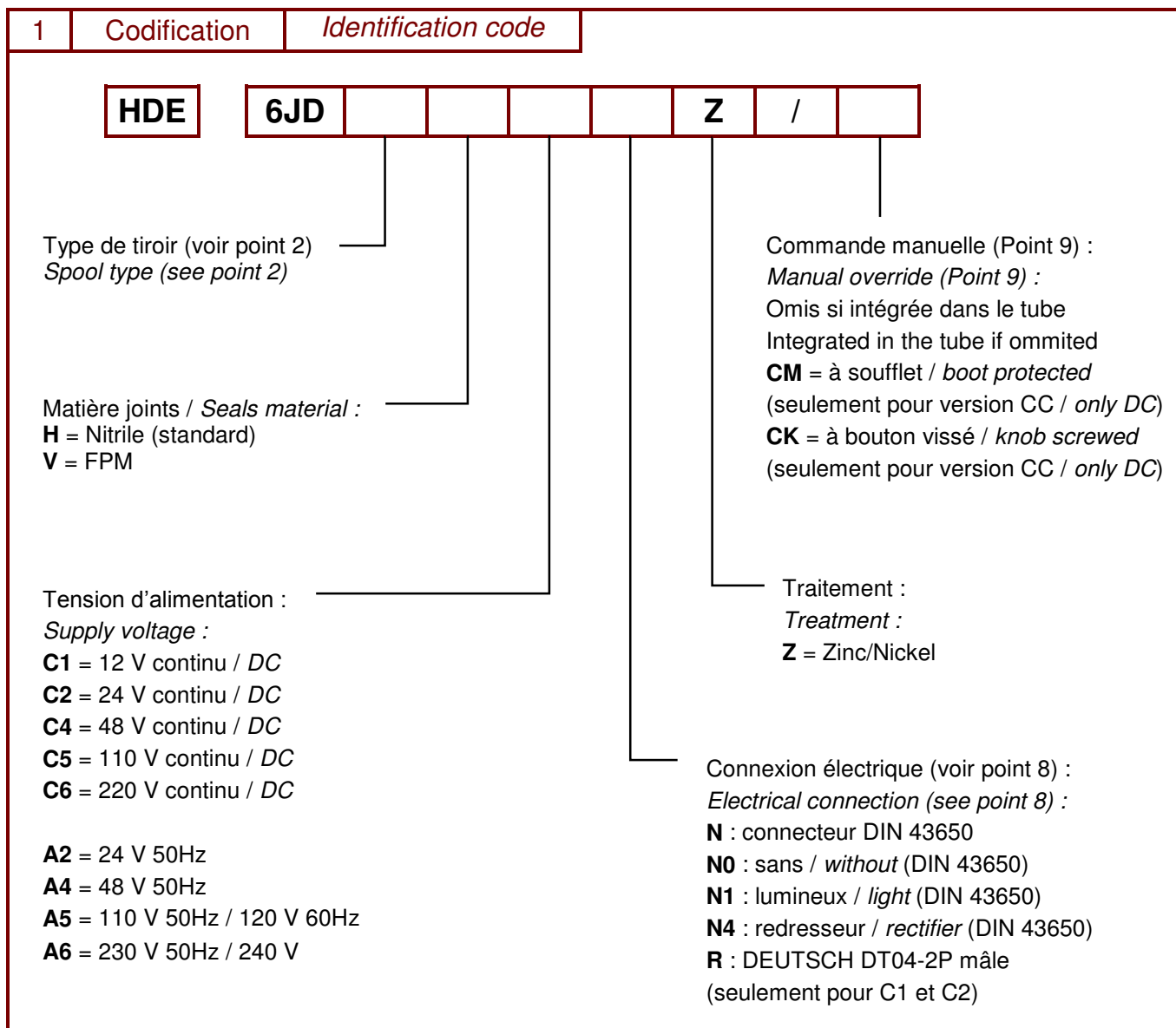





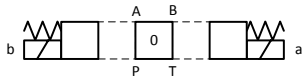
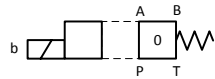
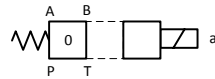
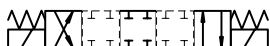



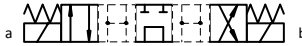

Caractéristiques	Features	
(avec une huile ayant une viscosité de 36cSt à 50°C / with a mineral oil 36cSt at 50°C)		
<b>Caractéristiques hydrauliques / Hydraulic features</b>		
Pression d'utilisation maximum / Maximum operating pressure P, A et B :	CC / DC	CA / AC
	320 bar	
T :	210 bar	140 bar
Débit maximum conseillé / Maximum recommended flow rate	80 l/min	
Pertes de charge / Pressure drop ( $\Delta P = f(Q)$ )	Point 3	
Limites d'utilisation / Operating limits	Point 4	
Degré de contamination du fluide / Fluid contamination degree	Selon ISO 4406 :1999 Classe 20/18/15	
Plage de viscosité du fluide / Fluid viscosity range	10 à 400 cSt	
Viscosité de fonctionnement préconisée / Recommended viscosity	25 cSt	
Plage de température du fluide / Fluid temperature range	-20°C / +80°C	
<b>Caractéristiques électriques / Electrical features</b>		
Caractéristiques électriques générales / General electrical features	Point 5	
Connexions électriques / Electrical connections	Point 8	
<b>Caractéristiques générales / General features</b>		
Plage de température ambiante / Ambient temperature range	-20°C / +50°C	
Encombrement en version CC / DC version overall dimensions	Point 6	
Encombrement en version CA / AC version overall dimensions	Point 7	
Le distributeur est livré avec des vis CHc M6 x 40 classe 12.9 traitées (Cs = 14 Nm) CHc M6 x 40 class 12.9 treated screws are delivered with the directional control valve (torque = 14 Nm)		

ELECTRO DISTRIBUTEUR A TIROIR	Taille 5 Size 5 NG 10	ISO 4401	<b>HDE 6JD</b>
<i>DIRECTIONAL CONTROL VALVE SPOOL TYPE</i>			

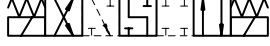

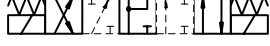
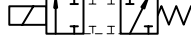
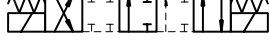
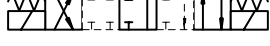
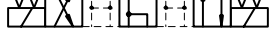
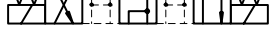
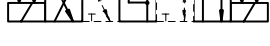
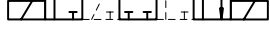
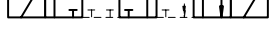
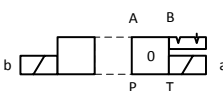
ELECTRO DISTRIBUTEUR A TIROIR	Taille 5 Size 5 NG 10	ISO 4401	<b>HDE 6JD</b>
DIRECTIONAL CONTROL VALVE SPOOL TYPE			

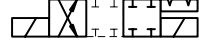
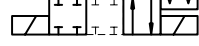
2	Type de tiroir	Spool type
	Fonction 4/3 4/3 function	Fonction 4/2 1 bobine côté A 4/2 function 1 coil side A
	Fonction 4/2 1 bobine côté B 4/2 function 1 coil side B	
		
		
	 <b>1A</b>	 <b>4A</b>
	 <b>1B</b>	 <b>4B</b>
	 <b>1C</b>	 <b>4C</b>
	 <b>1D</b>	 <b>4D</b>
	 <b>1E</b>	 <b>3A</b>
	 <b>1F</b>	 <b>3M</b>
	 <b>1G</b>	 <b>4UR</b>
	 <b>1H</b>	
	 <b>1J</b>	
	 <b>1K</b>	
	 <b>1L</b>	
	 <b>1M</b>	
	 <b>1N</b>	
	 <b>1P</b>	
		Fonction 4/2 indexée 4/2 detent function
		
		 <b>2A</b>
		 <b>2M</b>
		 <b>5A</b>
		 <b>5AR</b>
Note : d'autres types de tiroirs sont disponible sur demande / others spool types are available on request.		

3

Pertes de charge

Pressure drop

(Avec une huile minérale ayant une viscosité de 36 cSt à 50°C / with a mineral oil 36cSt at 50°C)

Pertes de charge avec tiroir en position excitée :  
Pressure drops with valve in energized position :

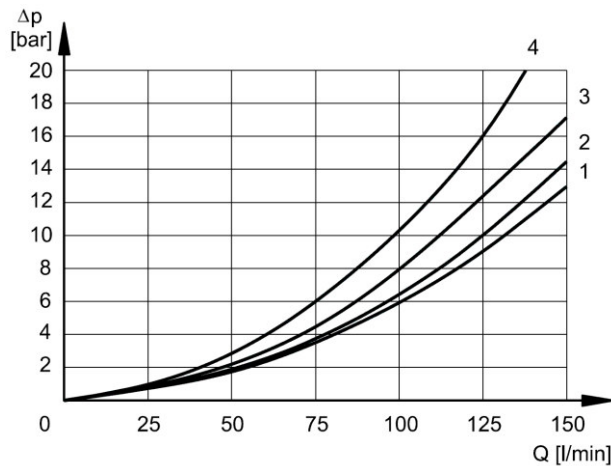

TIROIR	SENS DU DEBIT / DIRECTION FLOW			
	P→A	P→B	A→T	B→T
	COURBES DU DIAGRAMME			
1A	2	2	1	1
1B	3	3	1	1
1C	3	3	2	2
1D	1	1	2	2
1E	2	1	1	1
1F - 1J	3	3	2	2
1G	1	1	1	1
1H	1	2	1	1
1K - 1L	1	1	2	2
1M	3	3	2	2
3A	3	3	2	2
3M	3	3	2	2
4U	4	4		
2A - 2M - 5A	3	3	2	2

Pertes de charge avec tiroir en position centrale :  
Pressure drops with valve in neutral position :

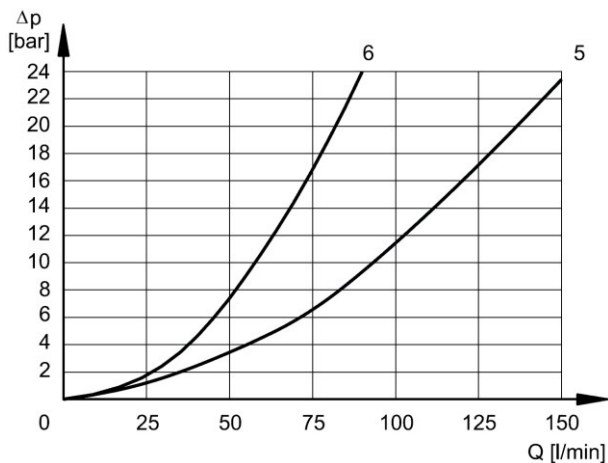

TIROIR	SENS DU DEBIT / DIRECTION FLOW				
	P→A	P→B	A→T	B→T	P→T
	COURBES DU DIAGRAMME				
1B					5
1C			6	6	
1D					5
1E		3			
1F - 1J			6		
1G	3	3			
1H	3				
1K - 1L					5

## 4

## Limites d'utilisation

## Operating limits

Les valeurs ont été obtenues selon l'ISO 6403, en considérant des bobines chaudes avec une tension d'alimentation égale à 90% de la tension nominale, et avec une huile minérale ayant une viscosité de 36cSt à 50°C et un degré de filtration, selon l'ISO 4406 :1999, classe 18/16/13.

The values have been obtained according to ISO 6403 norm with solenoids at rated temperature and supplied with voltage equal to 90% of the nominal voltage with a mineral oil 36cSt at 50°C and filtration according to ISO 4406:1999 class 18/16/13

## VERSION CC / DC VERSION

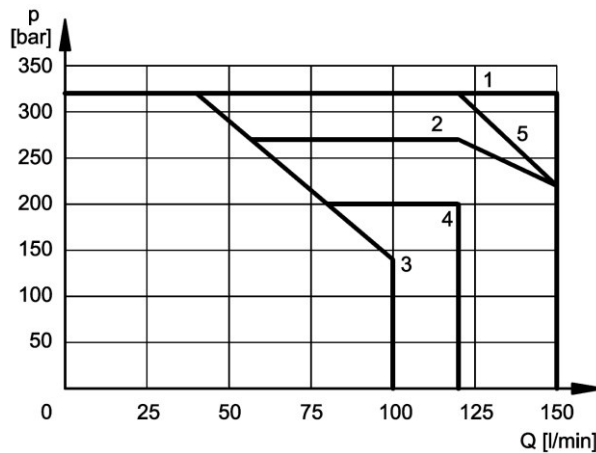

TIROIR	COURBE	
	P→A	P→B
1A	1	1
1B	1	1
1C	2	2
1D	3	3
1E	1	1
1F	1	2
1G	1	1
1H	1	1
1J	2	1
1K	3	3
1L	3	3
1M	1	1
3A	5	5
3M	4	4
4U	1	1
2A - 2M - 5A	1	1

## VERSION CA / AC VERSION

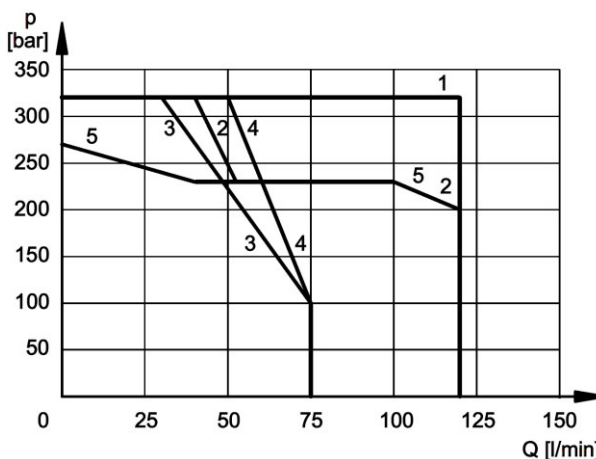

TIROIR	COURBE	
	P→A	P→B
1A	1	1
1B	2	2
1C	2	2
1D	4	4
1E	1	1
1F	1	2
1G	1	1
1H	1	1
1J	2	1
1K	3	3
1L	3	3
1M	2	2
3A	1	1
3M	5	5
4U	1	1
2A - 2M - 5A	1	1

ELECTRO DISTRIBUTEUR A TIROIR	Taille 5 Size 5 NG 10	ISO 4401	<b>HDE 6JD</b>
DIRECTIONAL CONTROL VALVE SPOOL TYPE			

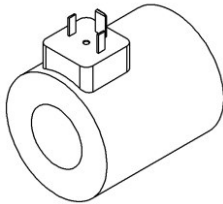
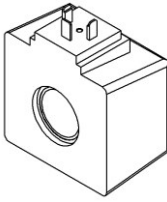
5	Caractéristiques électriques	Electrical features			
Caractéristiques générales / General characteristics					
Variation de la tension d'alimentation / Supply voltage tolerance		± 10 % Vnom			
Facteur de marche / Duty cycle		100%			
Cadence maximum / Maximum switching frequency		15.000 commutations/h			
Caractéristiques des bobines pour courant continu (valeurs ± 5 %) Direct current coils characteristics (values ± 5 %)					
Temps de réponse à l'excitation / Energizing switching time (ISO 6403)		100 à 150 ms			
Temps de réponse à désexcitation / De-energizing switching time (ISO 6403)		20 à 50 ms			
Tension nominale (Volt) Supply voltage (Volt)	Résistance à 20°C (Ω) Resistance at 20°C (Ω)	Courant absorbé (Ampère) Current consumption (A)	Puissance absorbée (Watt) Power consumption (Watt)		
12	3,2	3,75	45		
24	12	2	48		
48	49	0,98	47		
110	250	0,44	48		
220	1050	0,21	47		
					
Caractéristiques des bobines pour courant alternatif 50Hz (valeurs ± 5 %) Alternative current coils characteristics 50Hz (values ± 5 %)					
Temps de réponse à l'excitation / Energizing switching time (ISO 6403)		15 à 30 ms			
Temps de réponse à désexcitation / De-energizing switching time (ISO 6403)		20 à 50 ms			
Tension nominale (Volt) Supply voltage (Volt)	Résistance à 20°C (Ω) Resistance at 20°C (Ω)	Courant d'appel absorbé (A) Current consumption at inrush (A)	Courant de maintien absorbé (A) Current consumption at holding (A)	Puissance d'appel absorbée (VA) Power consumption at inrush (VA)	Puissance de maintien absorbée (VA) Power consumption at holding (VA)
24	0,53	25	3,96	600	95
48	2,09	12,5	2,3	600	110
110	10,9	5,2	0,96	572	105
230	52,7	2,8	0,46	644	105
					

ELECTRO DISTRIBUTEUR A TIROIR

DIRECTIONAL CONTROL VALVE SPOOL TYPE

Taille 5  
Size 5  
NG 10

ISO  
4401

HDE  
6JD

6 Encombrement en version CC

DC version overall dimensions

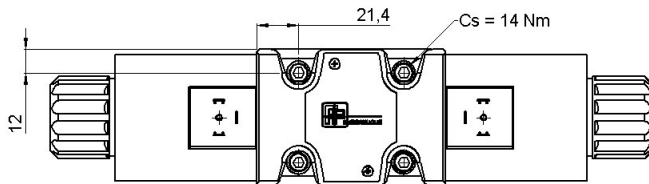
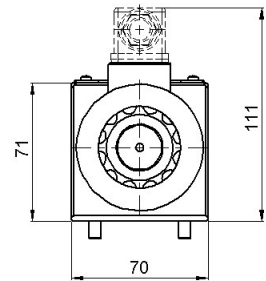
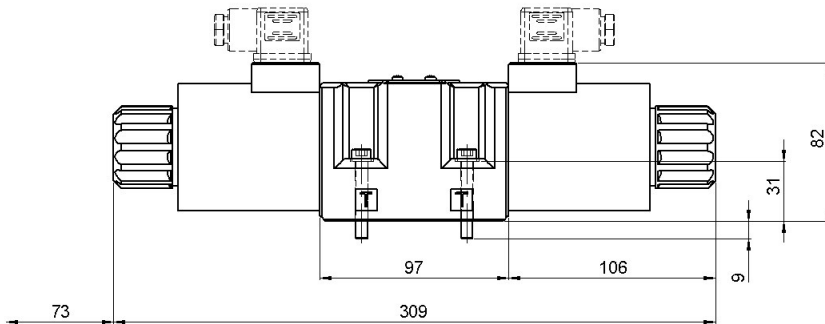

Version 2 bobines pour tiroir 1\*, 2\* et 5\*  
2 coils version for spool type 1\*, 2\* and 5\*

Version 1 bobine pour tiroir 3\* et 4\*

1 coil version for spool type 3\* and 4\*

Bobine côté A / coil side A : 3A, 3M, 4A...4D et 4UR

Bobine côté B / coil side B : 3AR, 3MR, 4AR...4DR et 4U

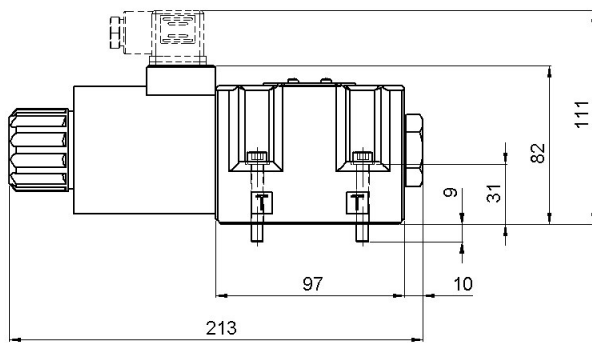

Bobine côté A  
Coil side A

Bobine côté B  
Coil side B

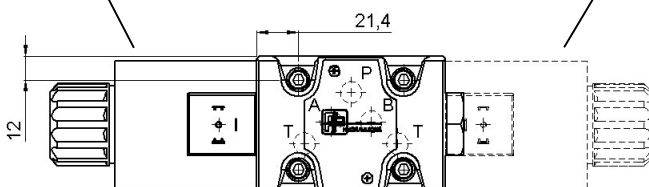

Dimensions en mm

Autres informations / Others informations :

Masse / Weight :

Monosolénoïde : 4,5 kg

Double solénoïde : 6,1 kg

ELECTRO DISTRIBUTEUR A TIROIR

DIRECTIONAL CONTROL VALVE SPOOL TYPE

Taille 5  
Size 5  
NG 10

ISO  
4401

HDE  
6JD

7 Encombrement en version CA

AC version overall dimensions

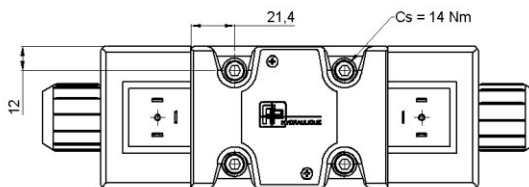
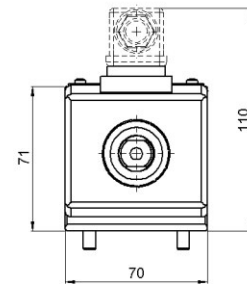
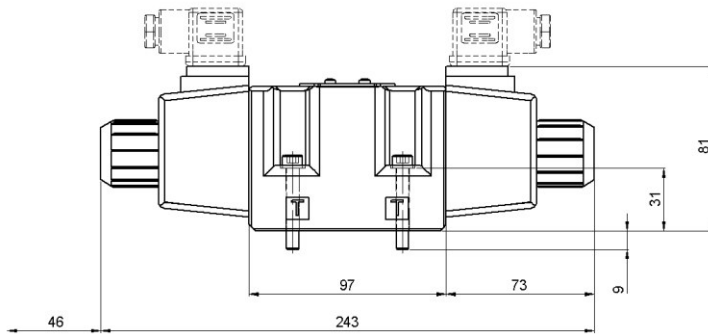

Version 2 bobines pour tiroir 1\*, 2\* et 5\*  
2 coils version for spool type 1\*, 2\* and 5\*

Version 1 bobine pour tiroir 3\* et 4\*

1 coil version for spool type 3\* and 4\*

Bobine côté A / coil side A : 3A, 3M, 4A...4D et 4UR

Bobine côté B / coil side B : 3AR, 3MR, 4AR...4DR et 4U

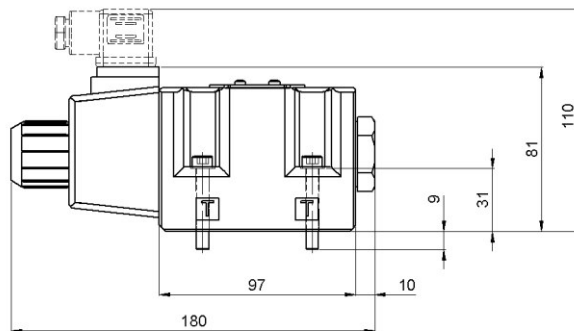

Bobine côté A  
Coil side A

Bobine côté B  
Coil side B

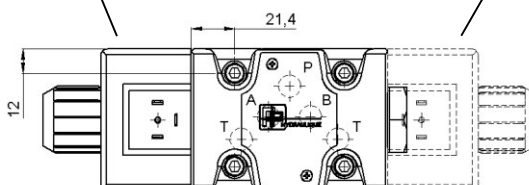

Dimensions en mm

Autres informations / Others informations :

Masse / Weight :

Monosolénoïde : 3,6 kg

Double solénoïde : 4,3 kg

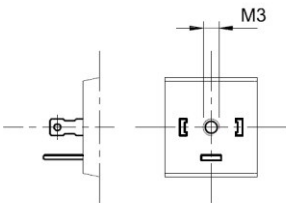
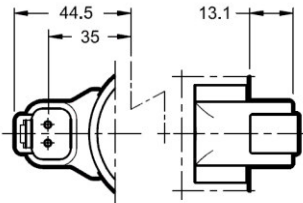

ELECTRO DISTRIBUTEUR A TIROIR	Taille 5 Size 5 NG 10	ISO 4401	<b>HDE 6JD</b>
<i>DIRECTIONAL CONTROL VALVE SPOOL TYPE</i>			

8	Connexions électriques	<i>Electrical connections</i>
<p>DIN 43650 (standard) : code N</p> 		<p>DEUTSCH DT04-2P mâle : code R</p> 

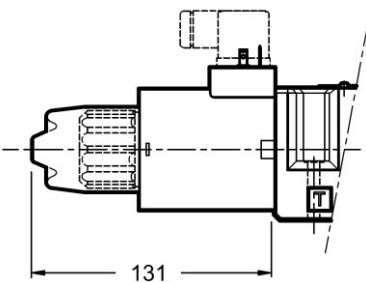
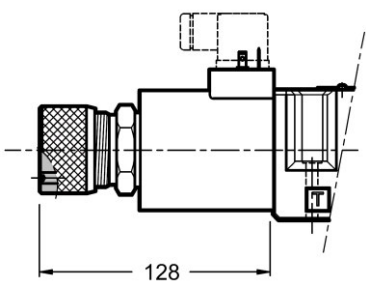
9	Commandes manuelles	<i>Manual overrides</i>
<p><b>CM</b> = commande manuelle à soufflet <i>boot protected manual override</i></p> 		<p><b>CK</b> = commande manuelle à vis avec bouton moleté <i>detent manual override with knurled knob</i></p> 

10	Pièces de rechange	<i>Spare parts</i>			
<b>Codes des bobines en courant continu / DC coil's code</b>					
<b>Tension (volt)</b>	<b>12</b>	<b>24</b>	<b>48</b>	<b>110</b>	<b>220</b>
DIN 43650	2001438	2001439	2002302	2002567	2002568
DEUTSCH DT04-2P	2002585	2002586			
<b>Codes des bobines en courant alternatif / AC coil's code</b>					
<b>Tension (volt) à 50 Hz</b>	<b>24</b>	<b>48</b>	<b>110</b>	<b>230</b>	
DIN 43650	2002569	2001440	2001441	2001442	
<b>Codes des autres pièces de rechange / Others spare parts code</b>					
<b>Designation</b>					<b>Code FPH</b>
Lot de 10 connecteurs noirs DIN 43650 / <i>10 black connectors pack</i>					1313700
Lot de 5 connecteurs blancs DIN 43650 / <i>5 white connectors pack</i>					1363200
Pochette de 20 joints de plan de pose / <i>20 mounting face seals pocket</i>					1843200

## Innovative Lösungen nach Ihren Anforderungen:

- Hydraulik, Aggregate und Ventile
- Druckprüfgeräte, Hochdruckhydraulik
- Produktionshilfsmittel, Maschinen

## Ein breites Sortiment hervorragender Produkte:

- Proportionalventile, Not-Stop-Ventile, auch für explosionsgefährdete Zonen
- Messverschraubungen, Rückschlagventile, Manometer
- Miniatur-Luft/Ölkühler

## Hydraulikkomponenten namhafter Hersteller,

- ausgewählt nach unseren hohen Anforderungen
- an Qualität und Liefertreue!

## Reparaturen und Wartungen

- an Hydraulikkomponenten und -anlagen
- durchgeführt von unseren Fachkräften.

Ihr Partner für  
Hydraulik und Maschinenbau

---